

DOOR BOTTOM SWEEPS

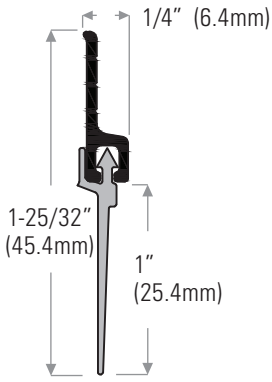

DS140AV Extruded aluminum mill finish with vinyl insert, grey

DS140DV Bronze anodized with black insert

DS140WW Painted white with grey insert

DSV40BL Replacement black insert

DSV40GREY Replacement grey insert

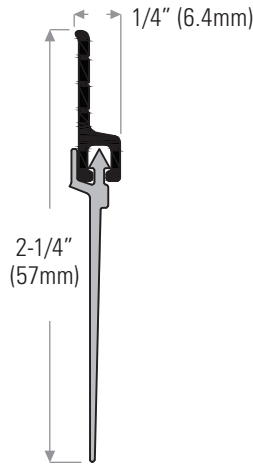

DS156AV Extruded aluminum mill finish with vinyl insert, grey

DS156DV Bronze anodized with grey insert

DS156WW Painted white with grey insert

DSV56GREY Replacement grey insert

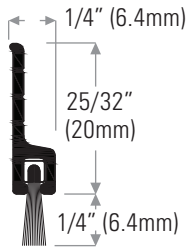

DS110AP Extruded aluminum mill finish with pile insert, black

DS110DP Bronze anodized

DSP10BL Replacement pile insert, black

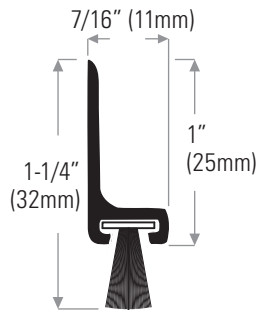

DS144AP Extruded aluminum mill finish with fin pile insert

DS144BP Painted brown

DS144WP Painted white

Lengths available: 36" (914mm), 48" (1219mm), 84" (2134mm), 96" (2438mm) & 180" (4572mm)



DS7545-270G
Replacement fin pile insert grey

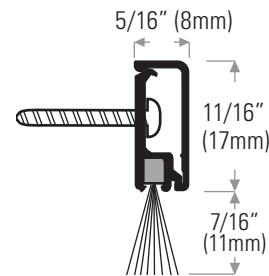

Sweep With Snap-On Cover To Conceal Screws



DS158A Extruded aluminum mill finish with nylon brush insert, black.

Lengths available: 36" (914mm) & 48" (1219mm)

DS158C Clear anodized

DS158D Bronze anodized

DS158W Painted white

DSBRUSH716BL Replacement brush insert, black

WEATHERSEALS (OVERHEAD, SLIDING & GARAGE DOOR)

OVERHEAD VIEW

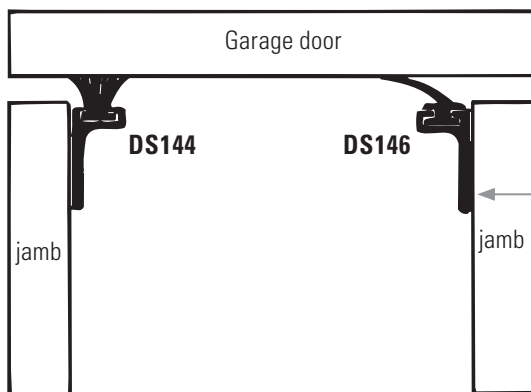

NO SCALE

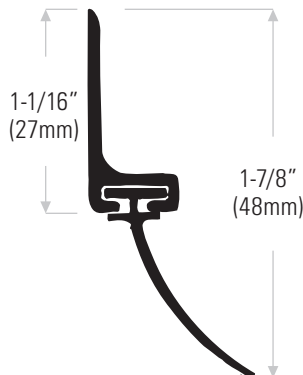

DS146AV Extruded aluminum mill finish TPE (T) insert

DS146BV Extruded aluminum brown painted with TPE (T) insert

DS146WW White painted with TPE (T) insert

DSN47V Replacement TPE (T) insert, grey