

Aluminum Door Shoe

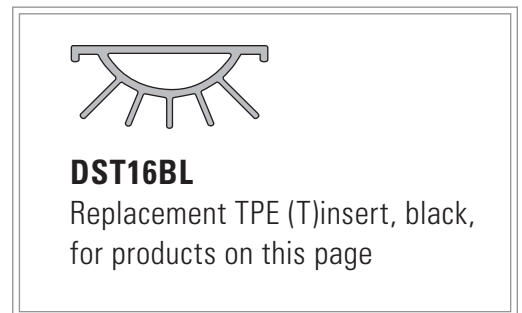
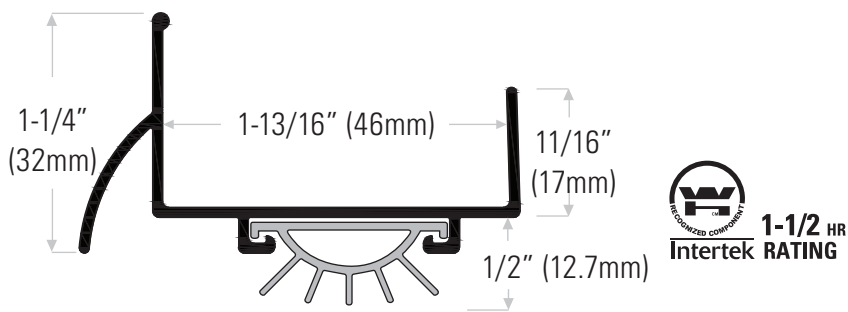

DS216AT Extruded aluminum mill finish with TPE (T) insert

DS216DT Bronze anodized

Door shoe is supplied with punched holes and screws and is available in the following NET lengths: 36" (914mm) & 48" (1219mm). Custom lengths available, call for manufacturing time.