



www.theDSgroup.com

Tomorrow's Innovative Solutions for Today's Doors & Windows

The DS Group Of Companies: Draftseal®, Kristrack®, Eclipse Architectural® & DSD Hardware

DraftSeal®

Residential Product: Door Shoe For Millennium Series Outswing Sill

DS2702 

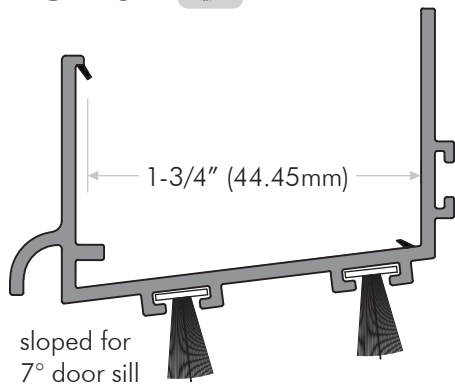

DS2702B PVC brown. Lengths available: 36", 48"

DS2702W PVC white. 32", 36", 48"

Head Office & Manufacturing Centre - Vancouver, Canada

7470 Buller Avenue, Burnaby, B.C. V5J 4S5 Canada

Ph: (604) 451-1080 • Fax: (604) 451-1140 • info@theDSgroup.com • Outside Vancouver, BC use toll free numbers Ph: 1-888-520-9009 Fax: 1-800-567-2887

Branch Offices & Manufacturing Centres Toronto, Canada & Los Angeles, USA • THE DS GROUP IS THE BRAND IMAGE OF A.K. DRAFT SEAL LTD.

© COPYRIGHT A.K. DRAFT SEAL LTD • This drawing remains the property of A.K. Draft Seal and all its affiliates. The information contained in this drawing is not to be disclosed to any party without written approval from A.K. Draft Seal.